

WS 2007 DK

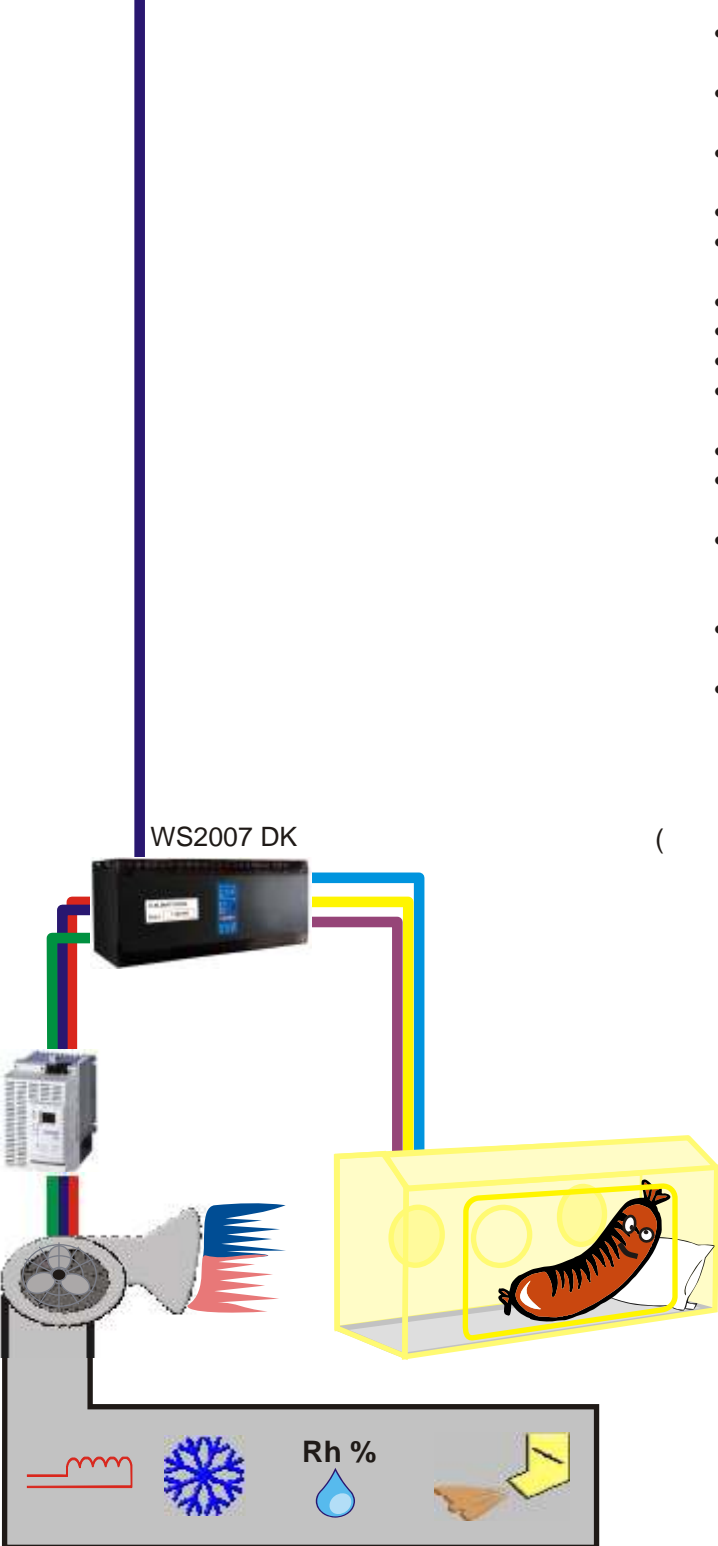

(),

,

,

20

20

10

10

(),

10

(, .),

,

,

():

10

,

,

,

,

,

(,),

,

(NO; NC).

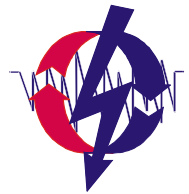

	<p>Ws-508TV/Ws-510TV LCD</p> <p>: 24± 5% VDC : 0-45 °C/90%RH : 8,5"/10,4"; 256 : : IP65 / : , PC[RS-232], PLC[RS-485],PLC[RS-232] : : IP65 : .21 .2 : : TS35(DIN) : .26 .4</p>
	<p>Ws-32MC /</p> <p>: 100~240 VAC : 24 VDC () : 12 x AC/DC (I =2A U =250V) : 20 x 24 VDC 120 Khz (0/24V) : : 1x RS232 () : : TS35(DIN) : .22 .4</p>
	<p>Ws-8EY</p> <p>: 24 VDC (Ws-32MC) : 8 x AC/DC (I =2A U =250V) : : 1x RS232 () : : TS35(DIN) : .22 .5</p>
	<p>Ws-4A2D -</p> <p>: 24 VDC (Ws-32MC) : 4 x 0~10V 4~20mA : 2 x 0~10V 4~20mA : : 1x RS232 () : : TS35(DIN) : .22 .5</p>
	<p>Ws-CBE</p> <p>- : PIN : : Ws-32MC : 1 x "Ethernet"</p>
	<p>Ws-SPD24301</p> <p>: 100-240VAC 47-63Hz 800mA : 24VDC 1.25A : : TS35(DIN) : : .22 .7</p>
	<p>Ws-232PO-9M-400 /</p> <p>Rs232- 9pin D-sub connector : : 150, 180, 400</p>
	<p>Ws-CD1</p> <p>- - -</p>

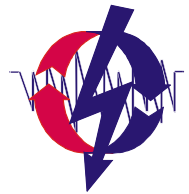

Rys.1

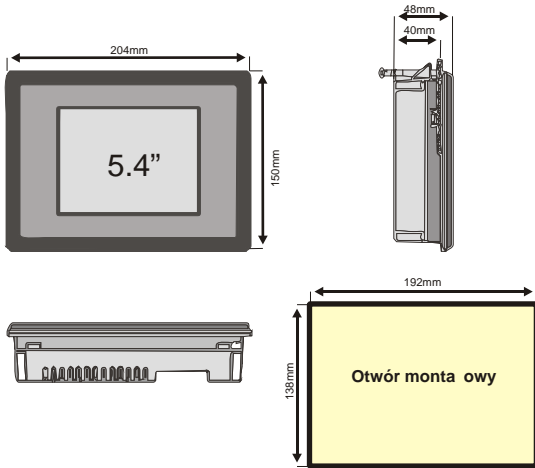

WS-506TV

Rys.2

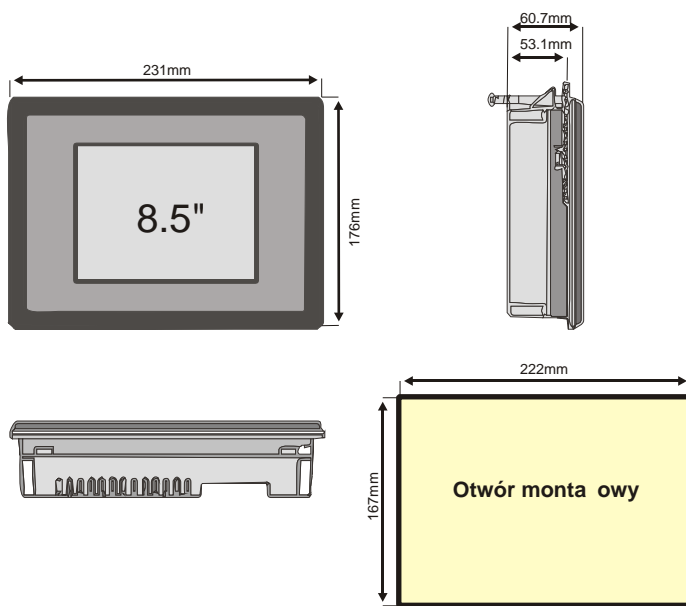

WS-508TV

Rys.3

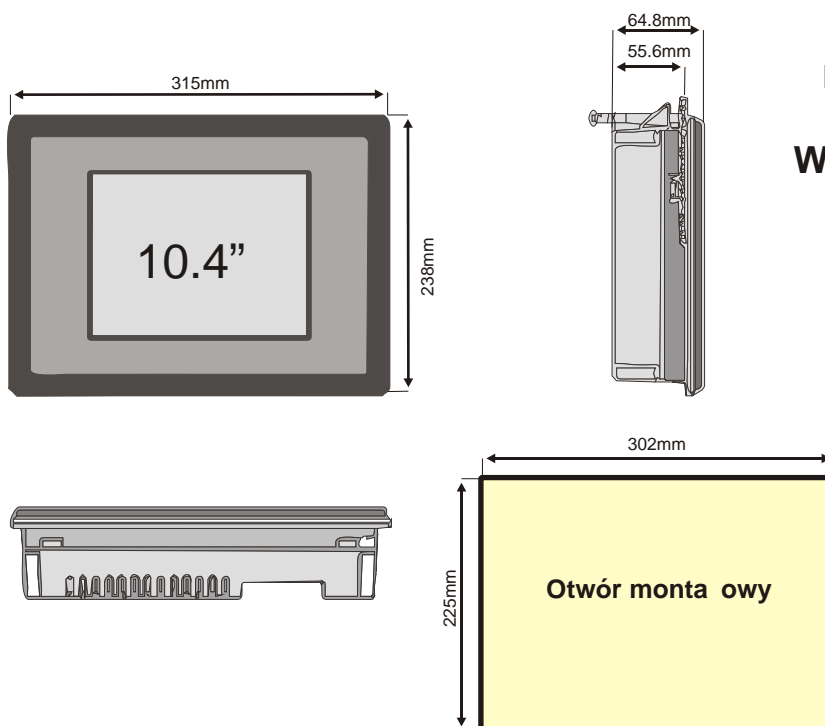

WS-510TV

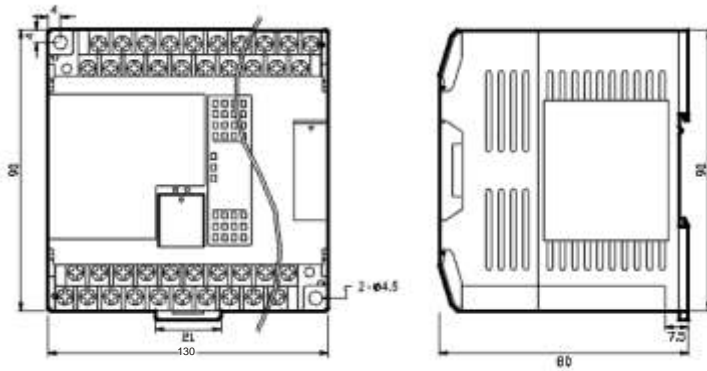
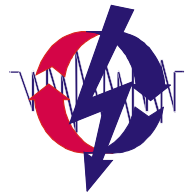

Rys.4

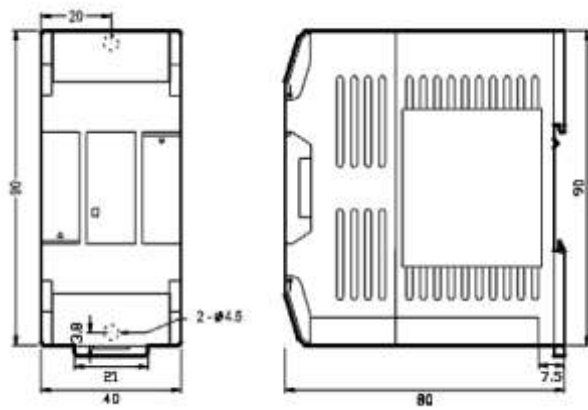

Rys.5

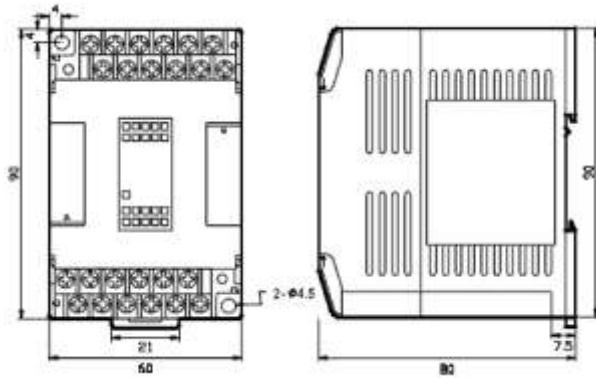

Rys.6

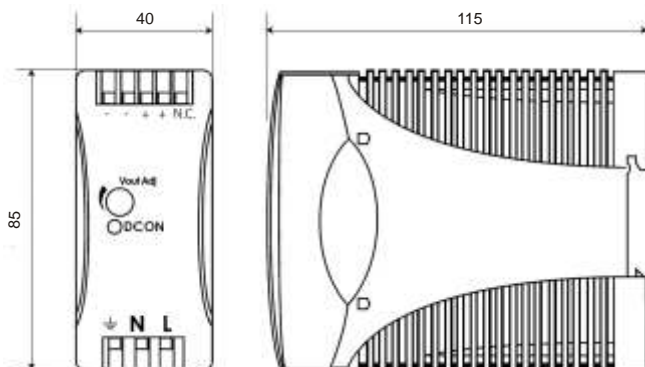

Rys.7